



Feedthrough Power Terminal

<p>RHT-FM6-3037-120A</p>	<p>RHT-FM6-3037-120A-C</p>	<p>材 质 Material PA66/合金铜(Copper Alloy)</p> <p>额定电流 Rated Current 120A</p> <p>额定电压 Rated Voltage 1000V DC Max.</p> <p>耐电压 Withstand Voltage 3000V</p> <p>颜 色 Color 红色 / 橙色 / 黑色</p>
		<p>19.8 4-Ø4.5 螺丝孔 Screw Hole</p> <p>19.8</p> <p>Ø16</p> <p>安装孔位 Mounting Hole Dimension</p>

<p>RHT-FM8M6-3343-120A</p>	<p>RHT-FM8M6-3343-120A-C</p>	<p>材 质 Material PA66/合金铜(Copper Alloy)</p> <p>额定电流 Rated Current 120A</p> <p>额定电压 Rated Voltage 1000V DC Max.</p> <p>耐电压 Withstand Voltage 3000V</p> <p>颜 色 Color 红色 / 黑色</p>
		<p>33</p> <p>24 4-Ø4.2</p> <p>24 33</p>

<p>RHT-FM8M5-3530-150A</p>	<p>RHT-FM8M5-3530-150A-C</p>	<p>材 质 Material PA66/合金铜(Copper Alloy)</p> <p>额定电流 Rated Current 150A</p> <p>额定电压 Rated Voltage 1000V DC Max.</p> <p>耐电压 Withstand Voltage 3000V</p> <p>安装螺丝 Installation Screw M4</p> <p>颜 色 Color 红色 / 黑色</p>
		<p>23 4-(M4) & Ø4.5 螺丝孔 Screw Hole</p> <p>23</p> <p>Ø18.5</p> <p>安装孔位 Mounting Hole</p>

<p>RHT-FM6-3026-120A</p>	<p>RHT-FM6-3026-120A-C</p>	<p>材 质 Material PA66/合金铜(Copper Alloy)</p> <p>额定电流 Rated Current 120A</p> <p>额定电压 Rated Voltage 1000V DC Max.</p> <p>耐电压 Withstand Voltage 3000V</p> <p>安装螺丝 Installation Screw M4</p> <p>颜 色 Color 红色 / 橙色 / 黑色</p>
		<p>19.8 4-Ø4.5 螺丝孔 Screw Hole</p> <p>19.8</p> <p>Ø16</p> <p>安装孔位 Mounting Hole</p>

<p>RHT-FM8M5-3543-150A</p>	<p>RHT-FM8M5-3543-150A-C</p>	<p>材 质 Material PA66/合金铜(Copper Alloy)</p> <p>额定电流 Rated Current 150A</p> <p>额定电压 Rated Voltage 1000V DC Max.</p> <p>耐电压 Withstand Voltage 3000V</p> <p>颜 色 Color 红色 / 橙色 / 黑色</p>
		<p>23 4-Ø4.5 螺丝孔 Screw Hole</p> <p>23</p> <p>Ø18.5</p> <p>安装孔位 Mounting Hole Dimension</p>

RHT-FM8M6-3356-150A	RHT-FM8M6-3356-150A-CA	RHT-FM8M6-3356-150A-CB	<p>材 质 Material PA66/合金铜(Copper Alloy)</p> <p>额定电流 Rated Current 150A</p> <p>额定电压 Rated Voltage 1000VDC Max.</p> <p>耐电压 Withstand Voltage 3000V</p> <p>颜 色 Color 红色 /黑色</p>

RHT-FM8M6-3547E-200A	RHT-FM8M6-3547E-200A-C	<p>材 质 Material PA66/合金铜(Copper Alloy)</p> <p>额定电流 Rated Current 200A</p> <p>额定电压 Rated Voltage 0-1000VDC Max.</p> <p>耐电压 Withstand Voltage 3000V</p> <p>颜 色 Color 红色 /橙色 /黑色</p>

RHT-FM8M5-5225-35-150A	RHT-FM8M5-5225-51-150A	RHT-FM8M5-5225-51-B-150A	<p>材 质 Material PA66/合金铜(Copper Alloy)</p> <p>额定电流 Rated Current 150A</p> <p>额定电压 Rated Voltage 1000VDC Max.</p> <p>耐电压 Withstand Voltage 3000V</p> <p>颜 色 Color 红色 /黑色</p>

RHT-FM8-3260-200A	RHT-FM8-3260-200A-C	<p>耐电压 Withstand Voltage $\geq 2000VAC/min$</p> <p>材 质 Material PA66/PBT(保护壳) PA66/PBT(Protective Case)</p> <p>合金铜 Copper Alloy</p> <p>额定电流 Rated Current 200A</p> <p>额定电压 Rated Voltage 0-1000V DC</p> <p>颜 色 Color 橙色 /黑色</p>

RHT-FM8-12M2-5027-52-200A	<p>材 质 Material PA66/合金铜(Copper Alloy)</p> <p>额定电流 Rated Current 200A</p> <p>额定电压 Rated Voltage 1000VDC Max.</p> <p>耐电压 Withstand Voltage 3000V</p> <p>颜 色 Color 红色 /橙色 /黑色</p>

RHT-SIM8-BSM6-3657P Lead-acid to Lithium Battery Conversion Connector	RHT-SIM8-BSM6-3657N Lead-acid to Lithium Battery Conversion Connector	<p>材 质 Material PA66+GF/合金铜(Copper Alloy)</p> <p>额定电流 Rated Current 250A</p> <p>额定电压 Rated Voltage 600VDC Max.</p> <p>耐电压 Withstand Voltage 3000V</p> <p>颜 色 Color 红色 /黑色</p>

RHT-FM8-3530-200A	RHT-FM8-3530-200A-C	<p>材 质 Material PA66/合金铜(Copper Alloy)</p> <p>额定电流 Rated Current 200A</p> <p>额定电压 Rated Voltage 1000VDC Max.</p> <p>耐电压 Withstand Voltage 3000V</p> <p>安装螺丝 Installation Screw M4</p> <p>颜 色 Color 红色 /橙色 /黑色</p>

RHT-SIM8-2-3638P Lead-acid to Lithium Battery Conversion Connector	RHT-SIM8-2-3638N Lead-acid to Lithium Battery Conversion Connector	<p>材 质 Material PA66+GF/合金铜(Copper Alloy)</p> <p>额定电流 Rated Current 250A</p> <p>额定电压 Rated Voltage 600VDC Max.</p> <p>耐电压 Withstand Voltage 3000V</p> <p>颜 色 Color 红色 /黑色</p>

RHT-FM8M6-3551C-200A



材 质 Material PA66/合金铜(Copper Alloy)
 额定电流 Rated Current 200A
 额定电压 Rated Voltage 1000VDC Max.
 耐电压 Withstand Voltage 3000V
 颜 色 Color 红色 / 黑色

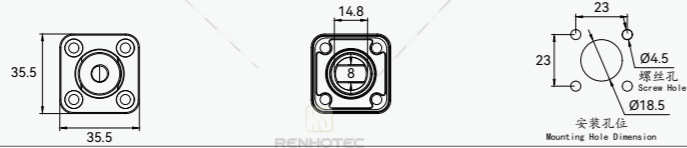

RHT-FM10-6548-600A



RHT-FM10-6548-600A-C



材 质 Material PA66/H62黄铜镀锡
PA66/H62 Brass (Tin Plated)
 额定电流 Rated Current 600A
 额定电压 Rated Voltage 1000V
 耐电压 Withstand Voltage ≥3000VAC/min
 颜 色 Color 红色 / 橙色 / 黑色

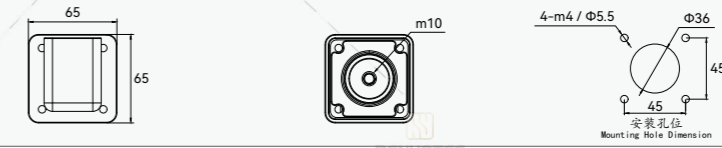

RHT-FM10-4368-300A



RHT-FM10-4368-300A-C



材 质 Material PA66/合金铜(Copper Alloy)
 额定电流 Rated Current 300A
 额定电压 Rated Voltage 1000V DC Max.
 耐电压 Withstand Voltage 3000V
 颜 色 Color 红色 / 橙色 / 黑色

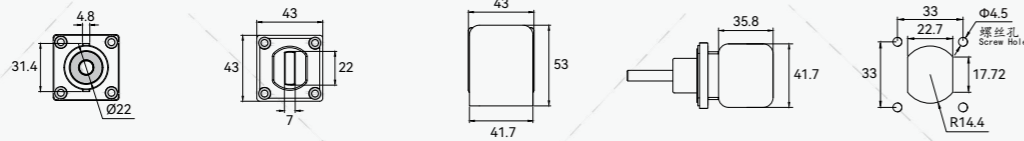

RHT-FM8-3457-32-500A



RHT-FM8-3457-32-500A-C



材 质 Material PA66/紫铜(Copper)
 额定电流 Rated Current 500A
 额定电压 Rated Voltage 1000V DC Max.
 耐电压 Withstand Voltage 3000V
 颜 色 Color 红色 / 橙色 / 黑色

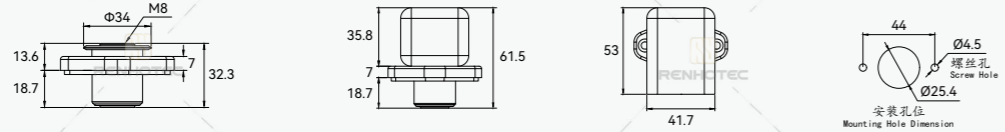

RHT-FM10-4970-500A



材 质 Material PA66/紫铜(Copper)
 额定电流 Rated Current 500A
 额定电压 Rated Voltage 1000V DC Max.
 耐电压 Withstand Voltage 3000V
 颜 色 Color 红色 / 橙色 / 黑色

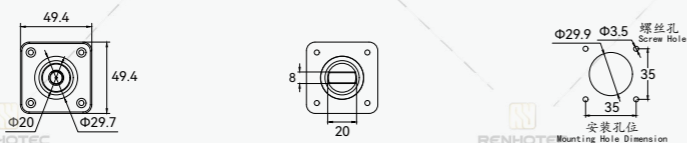

RHT-FM6TL-HT-3533
Iron stud, brass busbar



材 质 Material ABS/PBT/合金铜(Copper Alloy)
 额定电流 Rated Current 120A
 额定电压 Rated Voltage 1000V DC Max.
 耐电压 Withstand Voltage 3000V
 颜 色 Color 红色 / 黑色

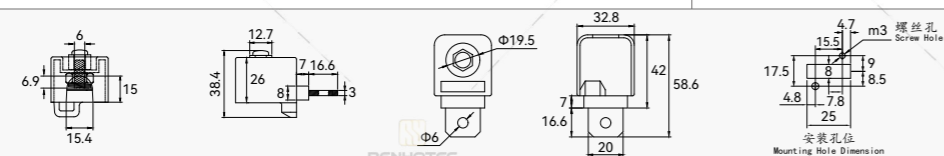

RHT-FM6TL-HT-3533-B
Iron stud, brass busbar, with arc-shaped groove



材 质 Material ABS/PBT/合金铜(Copper Alloy)
 额定电流 Rated Current 120A
 额定电压 Rated Voltage 1000V DC Max.
 耐电压 Withstand Voltage 3000V
 颜 色 Color 红色 / 黑色

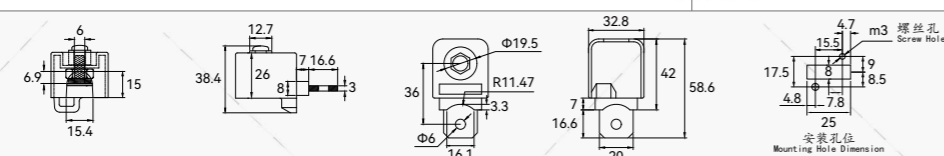

RHT-FM8TL-HT-3533
Iron stud, brass busbar



材 质 Material ABS/PBT/合金铜(Copper Alloy)
 额定电流 Rated Current 130A
 额定电压 Rated Voltage 1000V DC Max.
 耐电压 Withstand Voltage 3000V
 颜 色 Color 红色 / 黑色

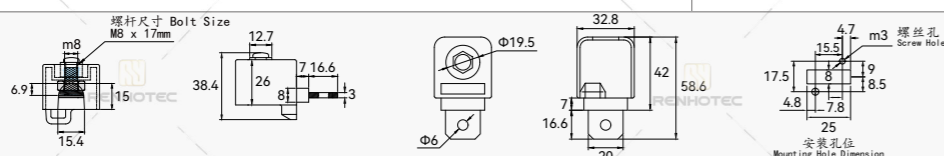

RHT-FM8TL-HT-3533-B
Iron stud, brass busbar, with arc-shaped groove



材 质 Material ABS/PBT/合金铜(Copper Alloy)
 额定电流 Rated Current 130A
 额定电压 Rated Voltage 1000V DC Max.
 耐电压 Withstand Voltage 3000V
 颜 色 Color 红色 / 黑色

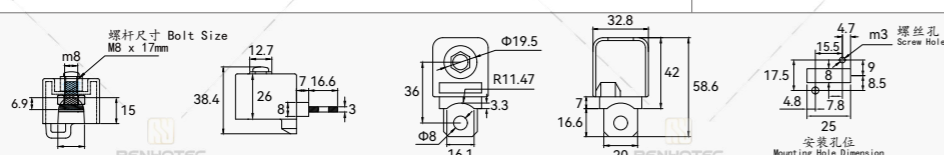

RHT-FM8TL-ZT-3533
Iron stud, red copper busbar

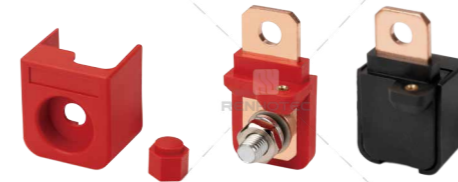

材 质 Material ABS/PBT/紫铜(Copper)
 额定电流 Rated Current 180A
 额定电压 Rated Voltage 1000V DC Max.
 耐电压 Withstand Voltage 3000V
 颜 色 Color 红色 / 黑色

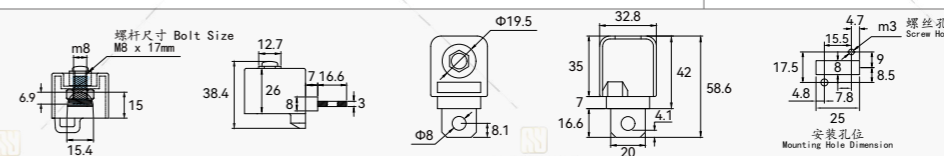

RHT-FM8TL-HT-48-3M
Brass busbar



材 质 Material ABS/PBT/合金铜(Copper Alloy)
 额定电流 Rated Current 150A
 额定电压 Rated Voltage 1000V DC Max.
 耐电压 Withstand Voltage 3000V
 颜 色 Color 红色 / 黑色

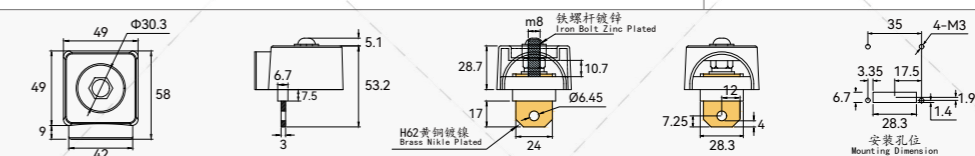

RHT-FM8TL-HT-48-3M-SC
Brass busbar, dual-output



材 质 Material ABS/PBT/合金铜(Copper Alloy)
 额定电流 Rated Current 150A
 额定电压 Rated Voltage 1000V DC Max.
 耐电压 Withstand Voltage 3000V
 颜 色 Color 红色 / 黑色

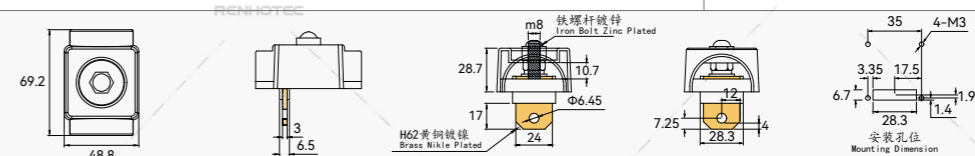

RHT-FM8TL-ZT-48-3M
Red copper busbar



材 质 Material ABS/PBT/紫铜(Copper)
 额定电流 Rated Current 220A
 额定电压 Rated Voltage 1000V DC Max.
 耐电压 Withstand Voltage 3000V
 颜 色 Color 红色 / 黑色

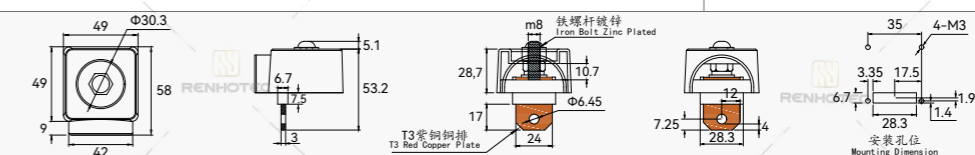

RHT-SIM5-BSM5-3437-DC

RHT-SIM5-2-3422-DC

RHT-SIM5-SOM6-3432-DC



RHT-SIM5-BSM5-3437-SC

RHT-SIM5-2-3422-SC

RHT-SIM5-SOM6-3432-SC



RHT-SIM6-BSM6-4045-DC

RHT-SIM6-2-4026-DC

RHT-SIM6-SOM6-4039-DC



RHT-SIM6-BSM6-4045-SC

RHT-SIM6-2-4026-SC

RHT-SIM6-SOM6-4039-SC



材 质 Material PA66/合金铜(Copper Alloy)
 额定电流 Rated Current 50A
 额定电压 Rated Voltage 1000V DC Max.
 耐电压 Withstand Voltage 3000V
 螺纹直径 Thread Diameter M5
 安装螺丝 Installation Screw M3
 颜色 Color 橙色 / 黑色



IF-SIM5-BSM5-3437

IF-SIM5-2-3422

IF-SIM5-SOM6-3432



材 质 Material PA66/合金铜(Copper Alloy)
 额定电流 Rated Current 120A
 额定电压 Rated Voltage 1000V DC Max.
 耐电压 Withstand Voltage 3000V
 螺纹直径 Thread Diameter M6
 安装螺丝 Installation Screw M4
 颜色 Color 红色 / 黑色



IF-SIM6-BSM6-3845

IF-SIM6-2-3828

IF-SIM6-SOM6-3841

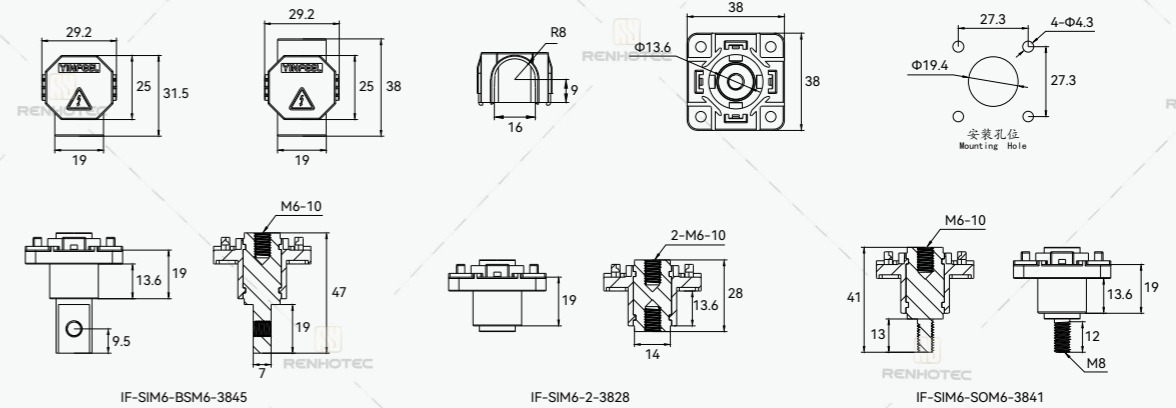
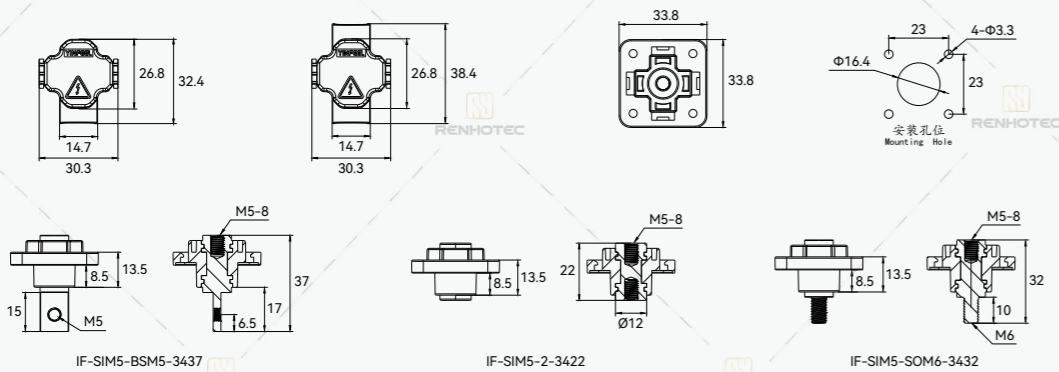

RHT-SIM6-BSM6-4750-DC

RHT-SIM6-2-4726-DC

RHT-SIM6-SOM8-4741-DC



RHT-SIM8-BSM8-5462-S-DC

RHT-SIM8-2-5434-S-DC

RHT-SIM8-SOM8-5450-DC



RHT-SIM6-BSM6-4750-SC

RHT-SIM6-2-4726-SC

RHT-SIM6-SOM8-4741-SC



RHT-SIM8-BSM8-5462-S-SC

RHT-SIM8-2-5434-S-SC

RHT-SIM8-SOM8-5450-SC



材 质 Material PA66/合金铜(Copper Alloy)
 额定电流 Rated Current 200A
 额定电压 Rated Voltage 1000V DC Max.
 耐电压 Withstand Voltage 3000V
 螺纹直径 Thread Diameter M6
 安装螺丝 Installation Screw M4
 颜 色 Color 红色 / 黑色

IF-SIM6-BSM6-4750



IF-SIM6-2-4726



IF-SIM6-SOM8-4741



材 质 Material PA66/合金铜(Copper Alloy)
 额定电流 Rated Current 300A
 额定电压 Rated Voltage 1000V DC Max.
 耐电压 Withstand Voltage 3000V
 螺纹直径 Thread Diameter M8
 安装螺丝 Installation Screw M4
 颜 色 Color 红色 / 黑色

IF-SIM8-BSM8-5462-S

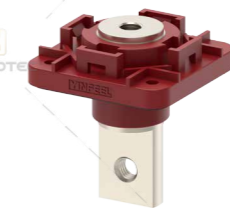

IF-SIM8-2-5434-S



IF-SIM8-SOM8-5450

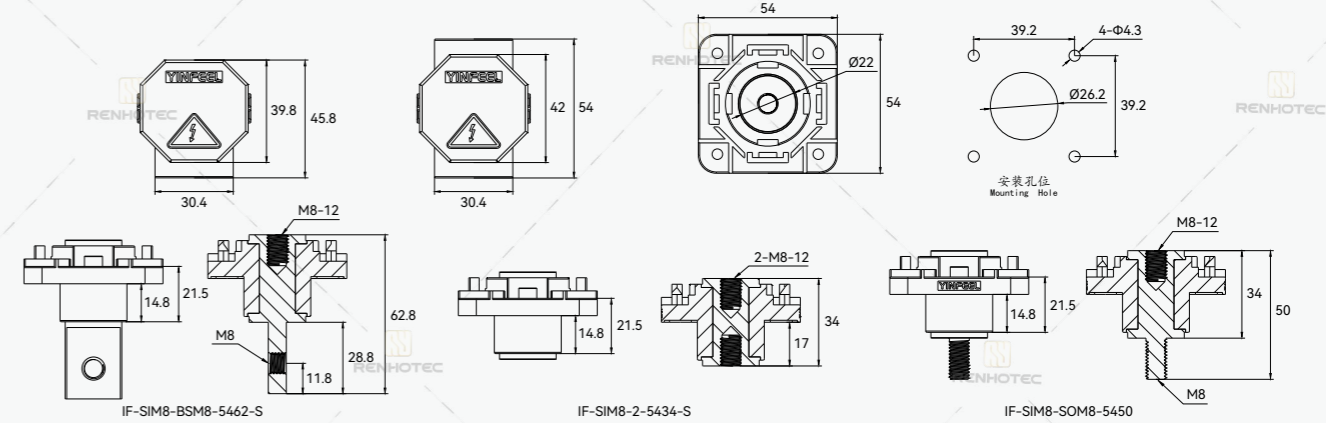
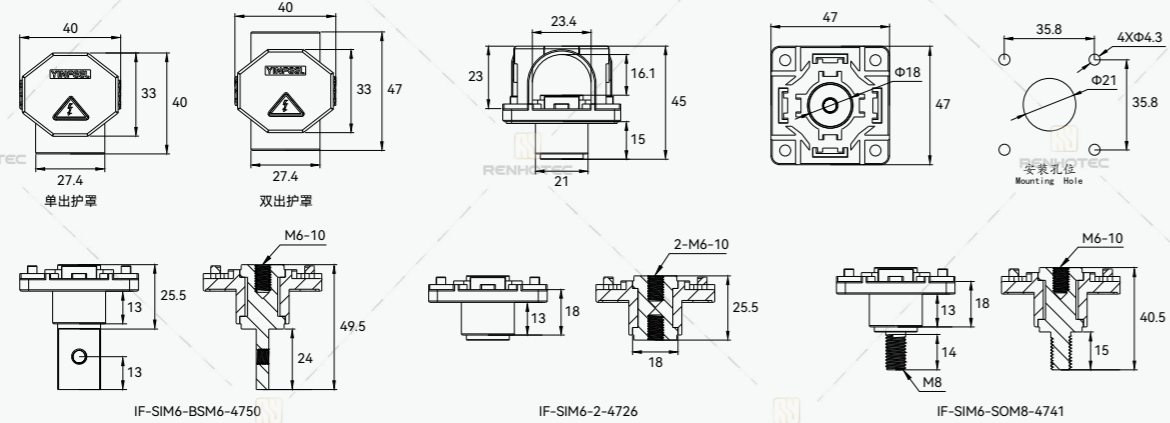

Screw Terminal Post

RHT-CM3

绝缘材质 Insulating Material	胶木(Bakelite)
金属材料 Metal Material	合金铜(Copper Alloy)
额定电压 Rated Voltage	600V AC
耐电压 Withstand Voltage	3000V
锁紧力 Tight Locking Force	1.5 N.m.
颜色 Color	红色 / 黑色

RHT-CM4

绝缘材质 Insulating Material	胶木(Bakelite)
金属材料 Metal Material	合金铜(Copper Alloy)
额定电压 Rated Voltage	600V AC
耐电压 Withstand Voltage	3000V
锁紧力 Tight Locking Force	2 N.m.
颜色 Color	红色 / 黑色

RHT-CM5

绝缘材质 Insulating Material	胶木(Bakelite)
金属材料 Metal Material	合金铜(Copper Alloy)
额定电压 Rated Voltage	600V AC
耐电压 Withstand Voltage	3000V
锁紧力 Tight Locking Force	2.5 N.m.
颜色 Color	红色 / 黑色

RHT-CM6

绝缘材质 Insulating Material	胶木(Bakelite)
金属材料 Metal Material	合金铜(Copper Alloy)
额定电压 Rated Voltage	600V AC
耐电压 Withstand Voltage	3000V
锁紧力 Tight Locking Force	3 N.m.
颜色 Color	红色 / 黑色

RHT-CM6-B

绝缘材质 Insulating Material	ABS
金属材料 Metal Material	合金铜(Copper Alloy)
额定电压 Rated Voltage	600V AC
耐电压 Withstand Voltage	3000V
锁紧力 Tight Locking Force	3 N.m.
颜色 Color	红色 / 黑色

RHT-CM8

绝缘材质 Insulating Material	胶木(Bakelite)
金属材料 Metal Material	合金铜(Copper Alloy)
额定电压 Rated Voltage	600V AC
耐电压 Withstand Voltage	3000V
锁紧力 Tight Locking Force	4 N.m.
颜色 Color	红色 / 黑色

RHT-CM10

绝缘材质 Insulating Material	胶木(Bakelite)
金属材料 Metal Material	合金铜(Copper Alloy)
额定电压 Rated Voltage	600V AC
耐电压 Withstand Voltage	3000V
锁紧力 Tight Locking Force	5 N.m.
颜色 Color	红色 / 黑色

RHT-999B

绝缘材质 Insulating Material	ABS
金属材料 Metal Material	铁(Iron)
额定电流 Rated Current	36A(6mm²线径) 60A(10mm²线径) 60A(10mm²线径)
额定电压 Rated Voltage	220/380V AC
耐电压 Withstand Voltage	3000V
颜色 Color	红色 / 黑色

RHT-FM4-14

绝缘材质 Insulating Material	ABS
金属材料 Metal Material	合金铜(Copper Alloy)
额定电流 Rated Current	50A
额定电压 Rated Voltage	220/380V AC
耐电压 Withstand Voltage	3000V
颜色 Color	红色 / 黑色

RHT-TM-M4-33

绝缘材质 Insulating Material	PC
金属材料 Metal Material	合金铜(Copper Alloy)
额定电流 Rated Current	30A
额定电压 Rated Voltage	220/380V AC
耐电压 Withstand Voltage	3000V
颜色 Color	红色 / 黑色

RHT-107

绝缘材质 Insulating Material	胶木(Bakelite)
金属材料 Metal Material	合金铜(Copper Alloy)
额定电流 Rated Current	80A
额定电压 Rated Voltage	220/380V AC
耐电压 Withstand Voltage	3000V
颜色 Color	红色 / 黑色

RHT-333

绝缘材质 Insulating Material	胶木(Bakelite)
金属材料 Metal Material	合金铜(Copper Alloy)
额定电流 Rated Current	150A
额定电压 Rated Voltage	220/380V AC
耐电压 Withstand Voltage	3000V
颜色 Color	红色 / 黑色

RHT-555

绝缘材质 Insulating Material	胶木(Bakelite)
金属材料 Metal Material	合金铜(Copper Alloy)
额定电流 Rated Current	200A
额定电压 Rated Voltage	220/380V AC
耐电压 Withstand Voltage	2000V
颜色 Color	红色 / 黑色

RHT-T555

绝缘材质 Insulating Material	胶木(Bakelite)
金属材料 Metal Material	合金铜(Copper Alloy)
额定电流 Rated Current	300A
额定电压 Rated Voltage	220/380V AC
耐电压 Withstand Voltage	2000V
颜色 Color	红色 / 黑色

RHT-TDB-M6M4-2-4

绝缘材质 Insulating Material	ABS
金属材质 Metal Material	合金铜(Copper Alloy)
额定电流 Rated Current	25A
额定电压 Rated Voltage	600V AC
耐电压 Withstand Voltage	3000V
颜色 Color	绿色 /黄色 /红色 蓝色 /黑色

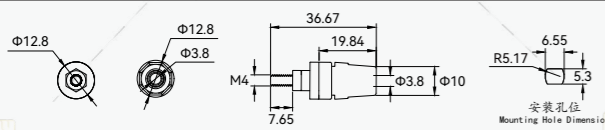
RHT-TMH-M6-2-4

绝缘材质 Insulating Material	ABS
金属材质 Metal Material	合金铜(Copper Alloy)
额定电流 Rated Current	60A
额定电压 Rated Voltage	600V AC
耐电压 Withstand Voltage	3000V
颜色 Color	绿色 /黄色 /红色 蓝色 /黑色

RHT-TMH-M8-4

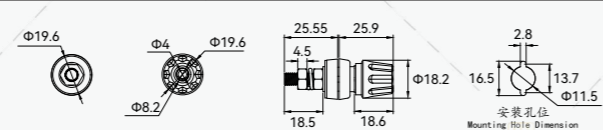
绝缘材质 Insulating Material	ABS
金属材质 Metal Material	合金铜(Copper Alloy)
额定电流 Rated Current	95A
额定电压 Rated Voltage	500V AC
耐电压 Withstand Voltage	3000V
颜色 Color	绿色 /黄色 /红色 蓝色 /黑色

RHT-TMH-M10-4

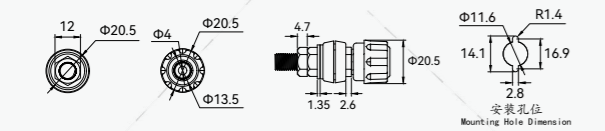
绝缘材质 Insulating Material	ABS
金属材质 Metal Material	合金铜(Copper Alloy)
额定电流 Rated Current	150A
额定电压 Rated Voltage	500V AC
耐电压 Withstand Voltage	3000V
颜色 Color	绿色 /黄色 /红色 黑色

RHT-TB-M6-4

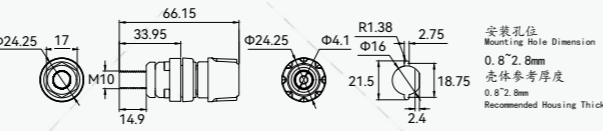
绝缘材质 Insulating Material	ABS
金属材质 Metal Material	合金铜(Copper Alloy)
额定电流 Rated Current	60A
额定电压 Rated Voltage	500V AC
耐电压 Withstand Voltage	3000V
颜色 Color	绿色 /黄色 /红色 蓝色 /黑色

RHT-TB-M8-4

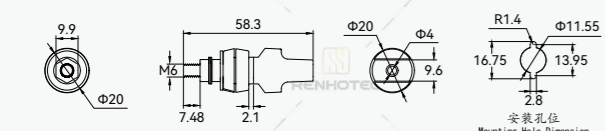
绝缘材质 Insulating Material	ABS
金属材质 Metal Material	合金铜(Copper Alloy)
额定电流 Rated Current	95A
额定电压 Rated Voltage	500V AC
耐电压 Withstand Voltage	3000V
颜色 Color	绿色 /黄色 /红色 蓝色 /黑色

RHT-TB-M10-4

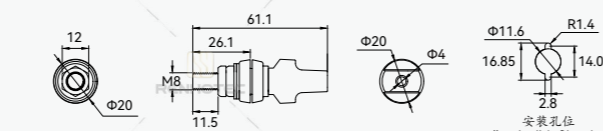
绝缘材质 Insulating Material	ABS
金属材质 Metal Material	合金铜(Copper Alloy)
额定电流 Rated Current	150A
额定电压 Rated Voltage	500V AC
耐电压 Withstand Voltage	3000V
颜色 Color	绿色 /黄色 /红色 蓝色 /黑色

RHT-TB-M12-4

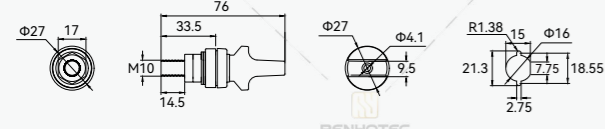
绝缘材质 Insulating Material	ABS
金属材质 Metal Material	合金铜(Copper Alloy)
额定电流 Rated Current	225A
额定电压 Rated Voltage	500V AC
耐电压 Withstand Voltage	3000V
颜色 Color	红色 /黑色

